

Servo-Angular Gearbox

DYNAGEAR

Installation and Operating Instructions

DYNAGEAR	D37 to D190
DYNAGEAR Economy	DE-DG55 to DE-DG115 DE-PL 55 to DE-PL90
DYNAGEAR HighRatio	D55HR to D190HR

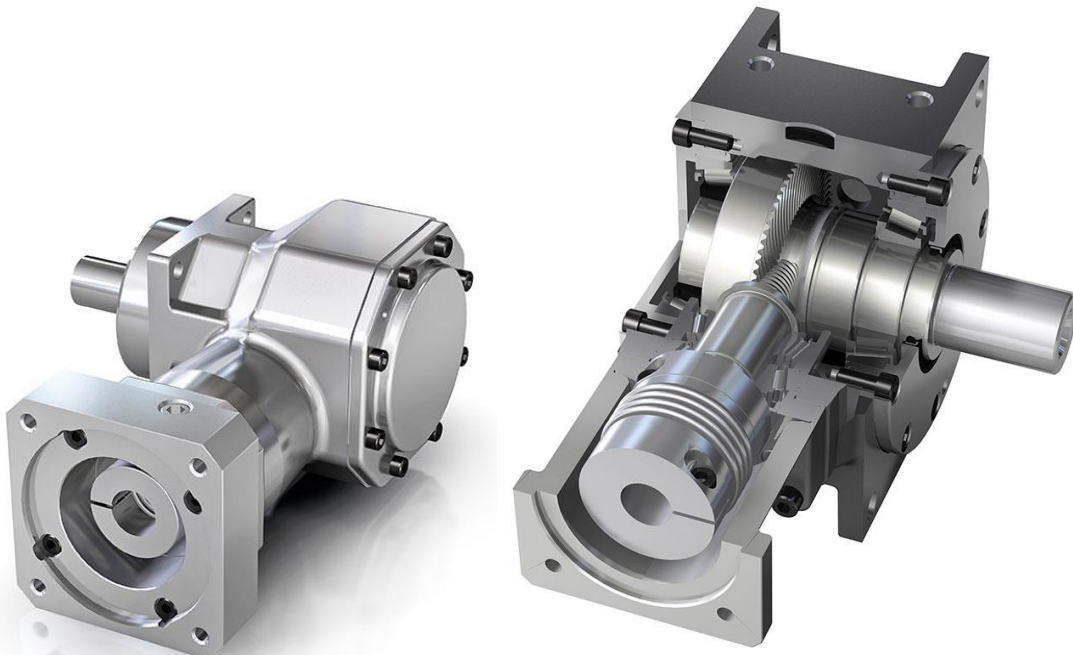

Issue 2021-07

Ident-No. BA 22A00040 EN

Table of Contents

1. General notes	4
1.1 Use of the operating instructions	4
1.2 Significance of the warning notes	4
1.3 Exclusion of liability	4
1.4 Copyright	4
2. Intended use of Nidec Graessner gear units	5
3. Conversions and alterations / modifications of the product	5
4. Set-up of gear unit / Technical data	6
4.1 Set-up of gear unit	6
4.2 Type designations	6
4.3 Performance tables DynaGear	8
4.4 Technical data DynaGear	8
4.5 Technical data DynaGear Economy	9
4.6 Type plate and designations	9
5. Safety notes	10
5.1 Basic duties	10
5.2 Qualified personnel	10
5.3 Environmental protection	10
6. Transport, storage, and long-term storage	11
6.1 Transport	11
6.2 Storage conditions	11
6.3 Long-term storage	11
6.4 Preparation of commissioning	11
7. Installation	12
7.1 General installation instructions	12
7.2 Gear unit installation in plant	12
7.3 Fitting of motors	12
7.4 Installation of the other fitted components	15
7.5 Finishing work	15
8. Commissioning	16
9. Operation of the DynaGear gear unit	16
9.1 General notes on operation	16
9.2 To be watched out for during operation	17
9.3 Irregularities	17

10. Faults, causes, remedy	18
10.1 General fault indications	18
10.2 Possible faults	18
11. Inspection and maintenance	19
11.1 General notes	19
11.2 Service intervals	19
11.3 Oil service life	19
11.4 Oil change	20
11.5 Checking the gear unit condition	20
12. Replacement parts, replacement part stocks, service department	20
12.1 Replacement parts	20
12.2 Replacement part stocks	20
12.3 Service department	20
13. Index (alphabetical)	21

1. General notes

1.1 Use of the operating instructions

These operating instructions are part of the product and must be read carefully before use and kept for future reference. It contains important information on the operation and servicing of the **DynaGear** gearbox range. These operating instructions are intended for all persons who carry out assembly, installation, commissioning, and service work on gear units from this gear unit series.





DynaGear gearboxes are components for installation in machines and are intended exclusively for the transmission, distribution, and multiplication of torque.

DynaGear are only designed for the application area described in chapter 2 "Technical Data". Other operating conditions must be agreed with Nidec Graessner GmbH & Co.KG and regulated by contract.

The gearboxes are manufactured to the latest technical standards and are delivered in a safe and reliable condition. They correspond to the status of the description in these operating instructions. We reserve the right to make technical modifications to components, while maintaining the performance and safety of the gear units.

1.2 Significance of the warning notes

The warnings are mentioned in the context in which a hazard may occur and refer to it. They specify the hazards and the possible consequences if the hazards are not eliminated. The notes on personal safety are highlighted by warning triangles indicating the types of hazard. Depending on the hazard level, the warning notices are shown as follows:

	Note Useful note or information
	Attention: Material damage may occur on the drive system or the environment
	Caution: Risk of physical injury! (<i>Danger of burns</i>)
	Warning: Possible hazardous situation - death or serious injury may occur! (<i>Danger of crushing</i>)
	Danger: Imminent danger, death, or serious bodily injury as a consequence! (<i>Danger of bodily harm/crushing</i>)

1.3 Exclusion of liability

Nidec Graessner GmbH & Co. KG does not assume any liability for damage and operating malfunctions resulting from non-compliance with these instructions.



1.4 Copyright

The copyright relating to these instructions is retained by **Nidec Graessner GmbH & Co. KG**, all rights reserved

These **installation and operating instructions** can be downloaded
from our website www.graessner.de

Regarding all technical queries please contact our product management or our service department:

Nidec Graessner GmbH & Co. KG THE GEAR COMPANY Kuchenaecker 11 D-72135 Dettenhausen	Service Department Product Management Department	Tel.: +49 (0)7157 123-0 Fax: +49 (0)7157 123 220 Fax: +49 (0)7157 123 212 mail@graessner.de www.graessner.de
---	---	---

	These operating instructions must be read carefully before use. Store in a safe place for future reference.
	If these operating instructions are not complied with, damage to the gear unit, operating faults, material damage and personal injury may occur. Nidec Graessner GmbH & Co. KG does not accept any liability for any resulting damages or faults.

2. Intended use of Nidec Graessner gear units

DynaGear gear units are components for installation in machines and are intended exclusively for the transmission, distribution, and multiplication of torque.

They comply with the machine directives (EN 292) and EMC directives to the extent they are applicable.

DynaGear gear units may only be used for the applications specified in the catalogue and in the associated technical specifications.

Any other use and/or any use exceeding those cases described in the catalogue and/or associated technical specifications is deemed not compliant with the intended use. The manufacturer does not accept any liability whatsoever for any damage resulting therefrom. This risk shall be solely borne by users.

DynaGear gear units can be used in a wide range of different applications; therefore, the responsibility for the specific application is transferred to the user at the time of use.

3. Conversions and alterations / modifications of the product

DynaGear gear units may not be modified in terms of design or safety without our approval.
Any unauthorized modification within the meaning of this provision excludes any liability on our part

4. Set-up of gear unit / technical data

4.1 Set-up of gear unit

DynaGear are angular gear units with case-hardened bevel gear pairs with Gleason hypoid toothing, for installation in machines and systems. In terms of performance capability, DynaGear matches all common servo motors and can be adapted variably via flange and coupling. The gearboxes have optimum centring on the mounting sides 1 and 3 and machined sides 4 and 5 with mounting threads. The shafts are supported by taper roller bearings in cantilevered support (input) and forked mounting (output), shaft seal rings made of NBR (nitrile rubber 'Buna') and FKM (fluorocarbon 'Viton'); flange seals by lamella sealing discs. Ratios mathematically accurate from 3.00:1 to 15.00:1. Gearboxes in solid shaft or hollow shaft design, for clutch transmission or direct mounting of the motor.

DynaGear gear units are in full compliance with the machine directives (EN 292) and EMC directives to the extent they are applicable.

4.2 Type designations

DynaGear D37 to D190

Output in solid shaft (build types 1L, 3L and 13L) and hollow shaft design 1LSV and 3LSV without motor lantern and without coupling

Output in solid shaft (build types 1L, 3L and 13L) and hollow shaft design 1LSV and 3LSV with motor lantern and coupling

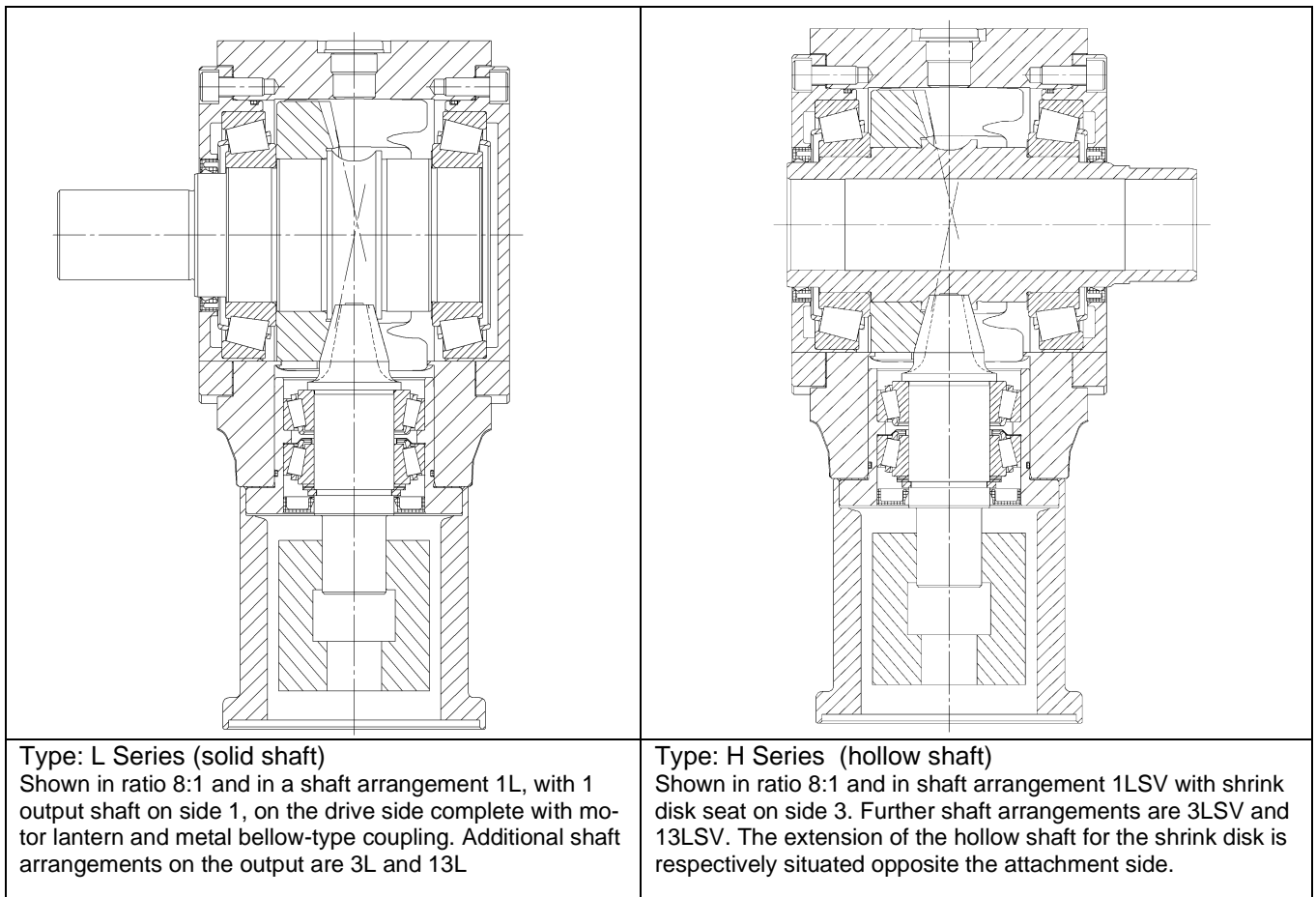

The bearings are designed with tapered roller bearings. In the case of the ratios 3:1 and 5:1, the drive pinions are designed as pinion shafts, from ratio 6:1 the drive pinions are shrunk into the drive shaft. The output-side bevel gears are shrunk onto the output shafts.

DynaGear High Ratio D55HR to D190HR

Output with solid shaft and hollow shaft

Drive with planetary gear stage for motor shaft and drive flange

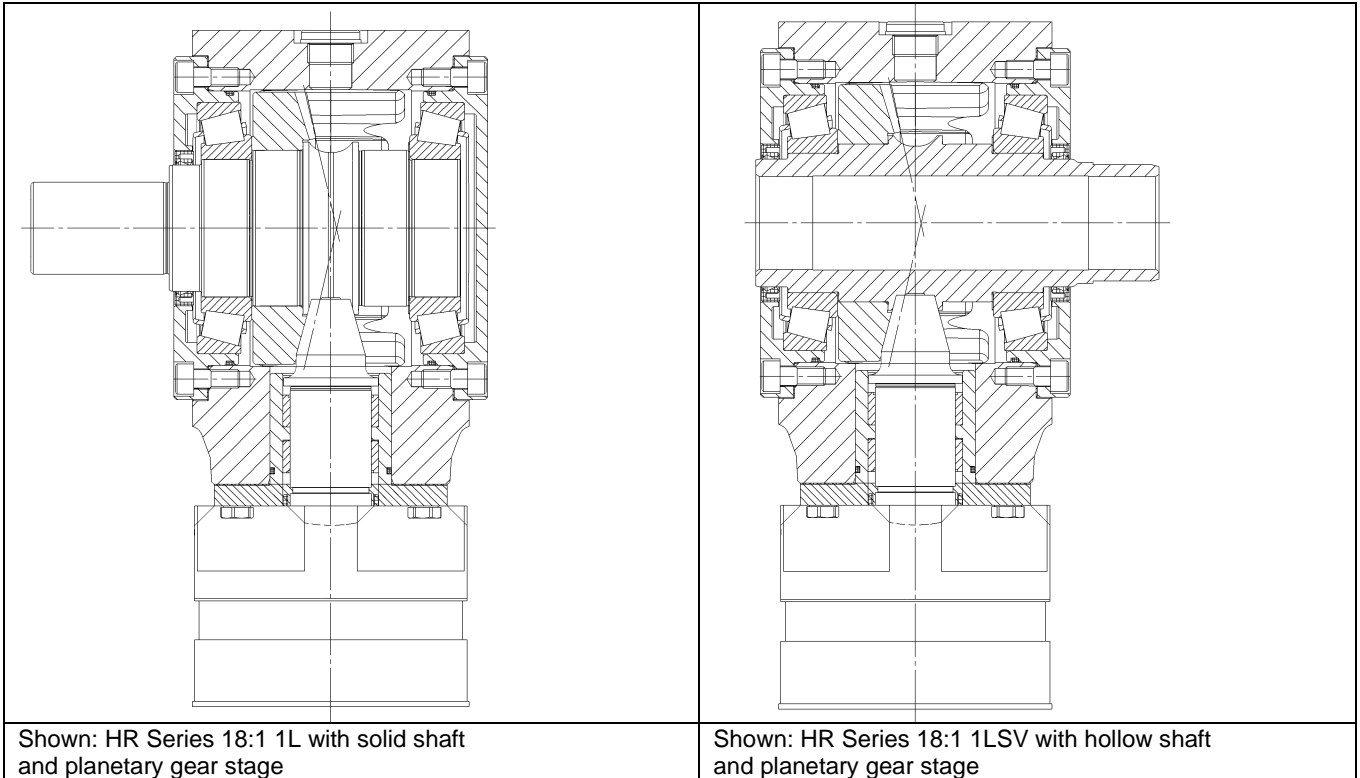

DynaGear Economy DE-DG

Output in solid shaft and hollow shaft design, corresponding to the standard DynaGear type series
Hollow shaft extended for shrink disk

DynaGear Economy DE-PL

Output in solid shaft, the dimensions correspond to those of a standard planetary gear unit

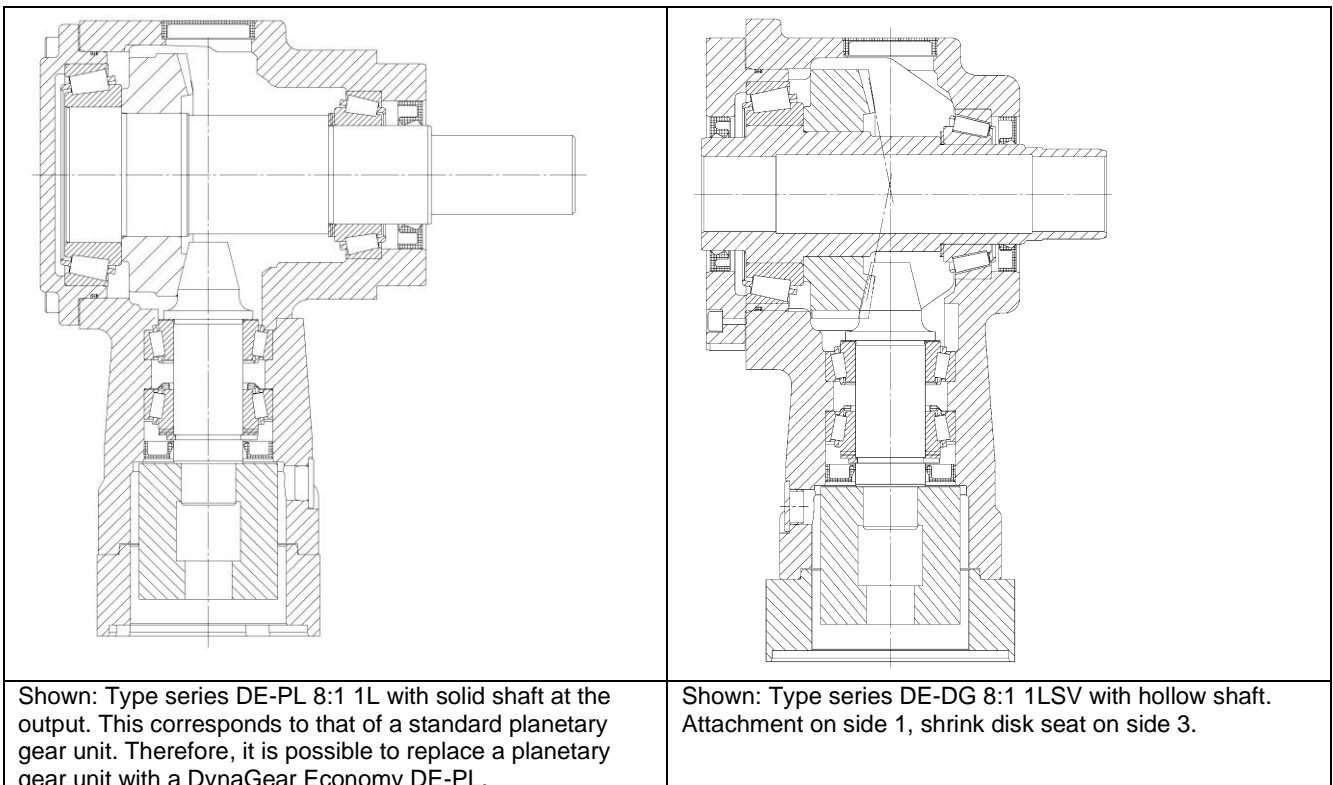

4.3 Performance Tables (DynaGear)

Nominal output torque T_{2N} (Nm)	D37	D55	D75	D90	D115	D130	D140	D160	D190
3:1	22	35	70	140	260	430	720	1100	1440
4:1	22	35	70	140	260	430	720	1100	1440
5:1	22	35	70	140	260	430	720	1100	1440
6:1	22	35	70	140	260	430	720	1100	1440
8:1	22	35	70	140	260	430	720	1100	1440
10:1	22	35	70	140	260	430	720	1100	1440
12:1	15	25	50	95	180	300	510	815	1020
15:1	15	25	50	95	180	300	510	815	1020

Performance Tables (DynaGear HighRatio)

Nominal output torque T_{2N} (Nm)	D55HR	D75HR	D90HR	D115HR	D130HR	D140HR	D160HR	D190HR
$i=16/18/24/30/32/$ $40/50/60/80/100$	35	70	140	260	430	720	1100	1440
	35	70	140	260	430	720	1100	1440

The max. acceleration torques as well as the emergency stop moments are comprised in the performance tables in the catalogue, download at www.graessner.de.

4.4 Technical Data (DynaGear)

	D37	D55	D75	D90	D115	D130	D140	D160	D190
Running noise at 3000 min ⁻¹ Partial load in dB(A)	<65	<66	<66	<68	<68	<70	<70	<72	<72
Weight (kg)	1,9	3,5	5,5	9,5	15,5	23,5	32,5	46,5	60
Average oil quantity (l)	0,05 0,07	0,06 0,08	0,12 0,15	0,3 0,4	0,55 0,75	0,8 1,0	1,1 1,3	1,8 2,2	2,3 2,8

Technical Data (DynaGear High Ratio)

	D55HR	D75HR	D90HR	D115HR	D130HR	D140HR	D160HR	D190HR
Running noise at 3000 min ⁻¹ Partial load in dB(A)	<66	<66	<68	<68	<70	<70	<72	<72
Weight (kg)	3,5	5,5	9,5	15,5	23,5	32,5	46,5	60
Average oil quantity (l)	0,06 0,08	0,12 0,15	0,3 0,4	0,55 0,75	0,8 1,0	1,1 1,3	1,8 2,2	2,3 2,8

Service life LH (h): >30,000 S5- load collective as design basis
 Lubrication: synthetic gear oil POA base, ISO –VG 150
 Installation positions: any
 Operating temperature: -10°C to 90°C
 Paint finish: Priming RAL 9005 – matt black
 Ex protection: Explosion-proof gearboxes available on request
 Protection class: IP 64

4.5 Technical data: DynaGear Economy DE-DG55 to DE-DG115 and DE-PL55 to DE-PL115

	DE-DG 55	DE-DG 75	DE-DG 90	DE-DG 115	DE-DG 55	DE-DG 75	DE-DG 90	DE-DG 115
Ratio	5/8/10				15			
Running noise at 1500 min ⁻¹ Partial load in dB(A)	<66	<66	<68	<68	<66	<66	<68	<68
Weight (kg)	2.5	4.2	8.2	13.5	2.5	4.2	8.2	13.5
Average oil quantity (l)	0.05 0.06	0.085 0.1	0.15 0.17	0.26 0.28	0,05 0.06	0,085 0.1	0,15 0.17	0.26 0.28

DynaGear Economy DE-PL55 to DE-PL90

	DE-PL 55	DE-PL 75	DE-PL 90		DE-PL 55	DE-PL 75	DE-PL 90	
Ratio	5/8/10				15			
Running noise at 1500 min ⁻¹ Partial load in dB(A)	<66	<66	<68		<66	<66	<68	
Weight (kg)	2,6	4,5	9,0		2,6	4,5	9,0	
Average oil quantity (l)	0,05 0,06	0,085 0,1	0,15 0,17		0,05 0,06	0,085 0,1	0,15 0,17	

Service life LH (h): >15,000 S5- load collective as a design basis
 Lubrication: synthetic gear oil POA base, ISO –VG 150
 Installation positions: any
 Operating temperature: -10°C to 90°C
 Paint finish: Priming RAL 9005 – matt black
 Ex protection: Explosion-proof gearboxes available on request
 Protection class: IP 64

4.6 Typing plate and designations

The typing plate comprises of:

	<ul style="list-style-type: none"> • Gear unit series
	<ul style="list-style-type: none"> • Type designation: D160 • Ratio: 6,00:1 • Shaft arrangement: 1LSV
	<ul style="list-style-type: none"> • The article number: 22160A730006
	<ul style="list-style-type: none"> • The serial number: 3184258
	<ul style="list-style-type: none"> • The customer number: 306390



Further technical data are specified in the “DynaGear” catalogue
 Can be downloaded at www.graessner.de
 Also available in print version from our product management and
 our service department.

5. Safety Notes

5.1 Basic duties

The safety notes listed here are used to avoid personal injury and material damage and must always be complied with and observed. For this purpose, persons with responsibility for the plant as well as qualified personnel working on the gear unit under its own responsibility must have read and fully understood these operating instructions, in order to:

- prevent any hazards for life and limb of users and any third parties.
- provide for the operational safety of the gear unit.
- exclude downtime and environmental damage due to incorrect handling.

5.2 Qualified personnel

This refers to persons having relevant education and training and a professional qualification who can detect risks in the handling of these products and avoid possible hazards.

Specialists within the meaning of these operating instructions are persons who are familiar with the set-up, mechanical installation, fault removal and maintenance of the gear units and have the following qualifications:

- Training in the field of mechanics with successfully completed professional training (mechanic, machine fitter, mechatronics engineer, toolmaker)
- Knowledge of these operating instructions

All specialists must wear protective clothing appropriate to their activity.

5.3 Environmental protection

- All existing packaging material must be disposed of in accordance with regulations or recycled.
- When changing the oil, the used oil must be caught in suitable vessels. Any pooled oil spills must be removed immediately by means of a binding agent. Any pooled oil spills must be removed immediately by means of a binding agent.
- Used oil, oil binding agent or oil-contaminated cleaning cloths must be disposed of in accordance with the relevant environmental protection regulations.
- **Disposal of the gear unit following the end of its service life:**
- Drain oil and preservation agents completely from the gear unit and dispose of as waste oil in accordance with the applicable national regulations.
- Housing parts, shafts, roller bearings and geared parts must be disposed of or recycled in accordance with applicable national regulations, depending on the relevant provisions also separately.



Serious personal injury and material damage due to:

- Incorrect use of the gear unit
- Incorrect installation or operation



Risks to life due to operational plant:

- When working on the gear unit, the gear unit must always be shut down.
- The drive must have been secured against unintentional activation (key switch or removal of fuses).
- At the point of switch-on, an information sign must be affixed indicating the shutdown.



Serious personal injury and material damage due to:

non-permissible removal of the necessary protective covers

6. Transport, storage and long-term storage

6.1 Transport

Any work regarding transportation, storage, siting, installation, commissioning, operation, service, and maintenance must be carried out by qualified personnel only.

Any damage identified after delivery must be communicated immediately to the transport company, if appropriate, commissioning/ activation must be excluded. The transportation of the gear unit must be carried out in a manner where personal injury and damage to the gear unit are avoided.



Danger:

Imminent danger! May result to serious bodily injury.
(*Danger of crushing bodies or body parts*)

Transport may only be carried out using suitable and designated means of transport.

When lifting eyebolts, they may only be attached to the intended holes with approved, adequately dimensioned lifting equipment. There must be no diagonal pull.

Installation-specific provisions and requirements must be complied with.

Relevant national and regional regulations for safety, accident prevention and environmental protection must be complied with.

6.2 Storage conditions

DynaGear gear units must only be stored in a closed condition, in a dry, dust-free, and low vibration (to avoid bearing damage) environment, without direct sunlight and at a temperature between -25 and +50°C. Series gear units can be stored for up to one (1) year.

Always check the oil level before taking the gear unit into service.

6.3 Long-term storage

If storage is planned for more than 1 year, the "long-term storage" version is recommended.

These gear units can be stored for up to 5 years maximum.

The external preservation is carried out by applying a permanent preservative agent.

The internal preservation is carried out with a synthetic gear oil based on PAO.

It is advisable to rotate the gear unit at regular intervals to prevent the bearings from sticking (jamming), the rotation also counteracts standstill marks and the shaft seals do not stick or become brittle.

6.4 Preparation of commissioning

Drain the oil and replenish with fresh oil before commissioning. If taken into service before the 5 years have elapsed, its function is guaranteed.

If commissioned at a date later than 5 years after being put into storage, the roller bearings, sealing elements and gear oil must all be replaced. For this purpose, it is probably best if you return the gear unit to our service department.

7. Installation

7.1 General installation instructions

The installation must only be carried out by **qualified, authorized, and trained personnel**.

The safety instructions in Section 3 must be complied with.

When transporting the gear unit, the notes in Section 6 must be complied with.

Suitable crane harness and lifting gear must be provided.

Before commissioning

- Fill the gear unit to the correct oil level, unless the gear unit is provided with lifetime lubrication
- Check if the transmission parts are correctly fitted before commissioning
- Do not deactivate monitoring and protection devices, even in test operation

If an oil level indicator or sight glass is available, the markings on them or the centre of the oil inspection glass, are considered the minimum.



Oil quantities (depending on ratio, speed, shaft arrangement and mounting position)

See **Technical data DynaGear and DynaGear HR** in chapter 4.4 (page 8)

Technical data DynaGear Economy DE-DG and DE-PL in chapter 4.5 (page 9)

7.2 Gear unit installation in plant

During installation or assembly ensure the following:

- An even support on a level, vibration-dampened and torsion-free substructure, stress and strain in the housing must be avoided.
- Tension-free assembly with combined flange or insertion mount attachment
- Exact alignment of the gear unit for direct coupling, comply with manufacturer's details

7.3 Fitting of motors

7.3.1 Drive with lantern and coupling

a. Installation of the coupling

The radially located clamping screw of the coupling half to be mounted is turned to the left until the screw head rests against the cross pin mounted in the counterbore. By turning the screw further, the coupling bore is elastically widened so that the coupling can easily be pushed onto the shaft. Proceed in the same way for disassembly.

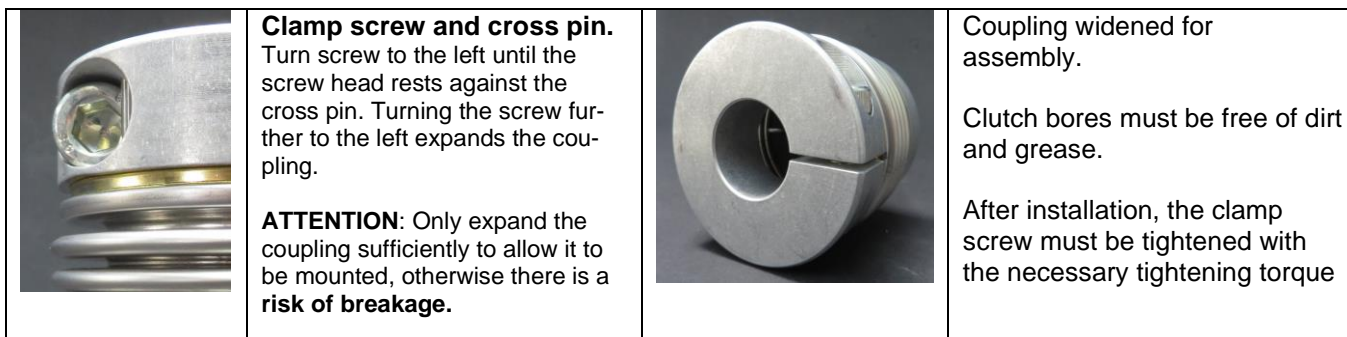

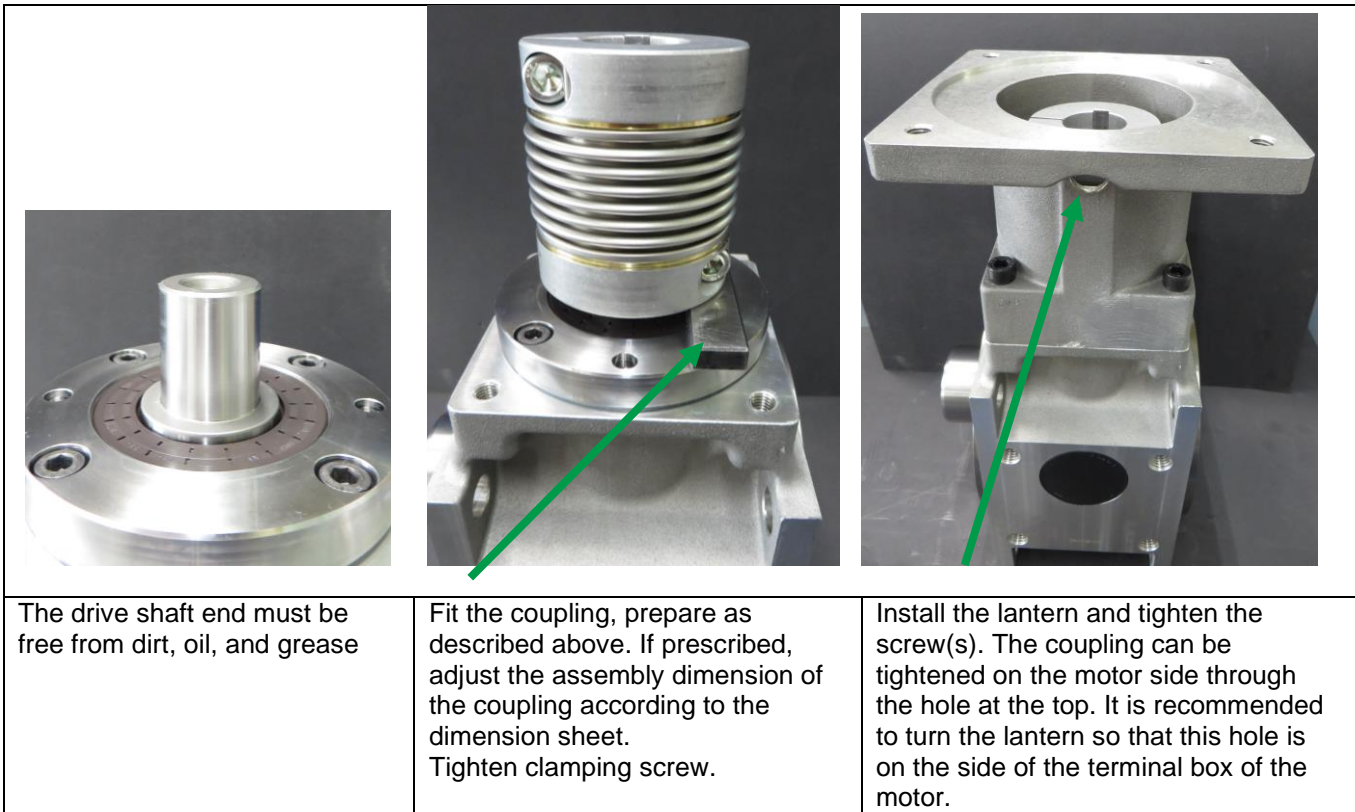

The drive shaft end must be free from dirt, oil, and grease

Fit the coupling, prepare as described above. If prescribed, adjust the assembly dimension of the coupling according to the dimension sheet.
Tighten clamping screw.

Install the lantern and tighten the screw(s). The coupling can be tightened on the motor side through the hole at the top. It is recommended to turn the lantern so that this hole is on the side of the terminal box of the motor.

For the mounting dimension of the coupling to the gearbox, refer to the corresponding dimension sheet. If nothing to the contrary has been stated there, push the coupling onto the shaft until it rests against the shaft shoulder. After tightening the coupling, place the motor lantern piece on the coupling and screw it tight, making sure that the holes for tightening the clamping screws on the coupling are on the same side as the terminal box on the motor.

Tightening torques of the clamp screws on the couplings

Screws: DIN 912, 10.9, galvanized

M4	M5	M6	M8	M10
5 Nm	8.5 Nm	14 Nm	35 Nm	69 Nm

b. Fit motor

Preferred mounting in vertical position. Always place the motor shaft on the coupling in alignment with the gear unit shaft. The metal bellows of the coupling must not be bent or axially offset during assembly.

Do **not** drive the motor in with a hammer, but slide it into the centering seat via the suitable holes and threads on the gear unit and motor using mounting screws until the motor is tight, then tighten the coupling on the motor side. There must be no strain and stress on the bearings and the coupling.

After tightening the clamping screws, insert plug into the bore.

	<p>Attention to damage to gear unit:</p> <ul style="list-style-type: none"> ▪ Incorrect installation can cause the coupling to be offset or bent! ▪ Tension in the bearings can cause overheating, resulting in bearing damage with blockage. ▪ The shaft sealing rings and the running surfaces of the shafts must not be damaged when the coupling parts are fitted. Otherwise, leakage may occur!
---	--

Upon request, other coupling types and variants may be installed!
Basically, we refer to the operating instructions of the respective coupling manufacturer!

7.3.2 Drive via clamping hub and clamping ring screw (DynaGear HighRatio)

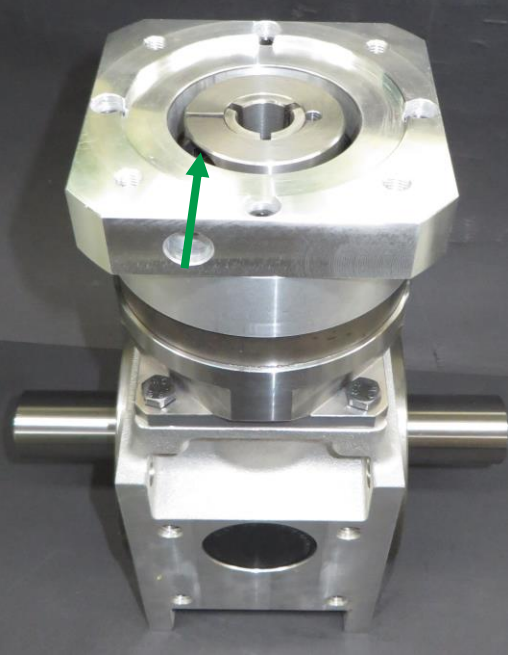
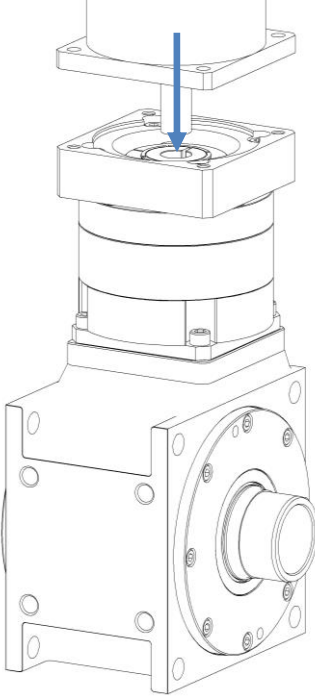
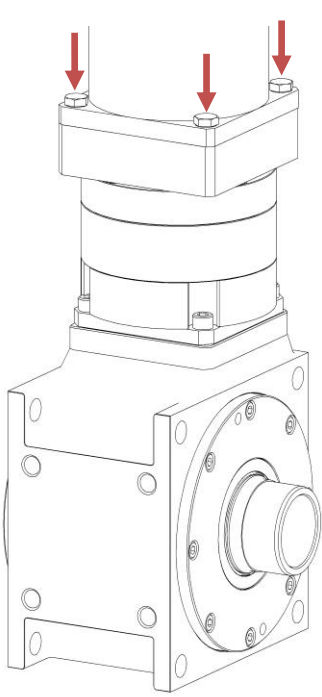
		
<p>Clean the clamping hub, bore and flange surface on the planetary pre-stage so that they are free of dirt and grease. Do the same on the motor shaft and motor flange. Position the clamping hub with clamping screw, and then open.</p>	<p>Preferred mounting position: gear unit and motor vertical. Insert the motor into the gear unit from above.</p>	<p>The motor must be in tension-free contact with the gear unit flange, then screw in screws with screw-locking paste and tighten them crosswise to the specified tightening torque.</p>

Tightening torques for screws on flanges, lanterns and motors DIN 912, 8.8

M5	M6	M8	M10	M12
6 Nm	10 Nm	25 Nm	50 Nm	86 Nm



Tighten the clamping screw in the clamping hub with suitable MA,
Fit the plug.

Tightening torques of the clamp screws on the clamping hubs

Gear unit	D55HR	D75HR	D90HR	D115HR	D130HR	D140HR	D160HR	D190HR
Tightening torque clamp screw M_A (Nm)	6	9	9	up to $\varnothing 14$ - 11 Nm from $\varnothing 19$ - 20 Nm		up to $\varnothing 24$ - 20Nm from $\varnothing 28$ - 35Nm		
Width across flats Allen key (mm)	4	4	4	5	5	5	5	5

7.4 Installation of the other fitted components

The drive and output elements (gears, belt wheels, jointed shafts etc.):

- Must have been balanced with G 6.3
- Must only be fitted using suitable fitting and withdrawal devices
- Must be axially secured even if they have been shrunk on

When using suitable tensioning elements, the tightening torques must be considered

The components must be mounted onto the shaft as far as is specified in the article-related dimension sheet.

In the case of a belt drive the correct belt tension must be assured, comply with the manufacturer's instructions in this regard. The permissible transversal forces for the shaft must not be exceeded (see catalogue).

Drive and output elements must be covered by contact protection

7.5 Finishing work

- Before fitting protective covers check again the correct oil level in the gear unit.
- Check for even running free from strains, stresses, and any faults.
- Fit protective covers.
- Carefully clear away all tools as well as any parts not fitted.



Attention:

Due to **incorrect installation** the gear unit can be damaged and become unusable. Such damage may be caused by falling objects, dumping, welding work or insufficient attachment.

The operator must ensure:

- The gear unit must be protected against any falling objects and dumping
- Welding work must not be carried out on any part of the drive
- The gear unit must not be used as a ground point for electric welding work
- All mounting options assigned to the build type must be used.
- Any screws that have become unusable during assembly and disassembly must be replaced by new ones featuring the same design and strength class.

8. Commissioning

The commissioning (*taking up operation in accordance with the intended use*) of the **DynaGear** gear unit is prohibited until it has been determined that the machine or plant complies with the provisions of the EU machine directive.

Before commissioning check the correct attachment of the transmission parts.

Check the oil level

Do not deactivate monitoring and protection devices, not even during test operation.

With DynaGear gear units, the use of an aeration and ventilation filter is not provided for. In special cases, with very high operating temperatures, an aeration and ventilation filter may help decrease the temperature and avoid leakages in S1 operation. Please contact our product management in this regard.

The first start-ups must be carried out without load and at low speeds, until it is ensured that all roller bearings, bevel gears and shaft seals are wetted with oil, then increase speed to approx. 500 min⁻¹
After approx. 30 min. slowly increase speeds until operational speed is reached, running in time at idle approximately 90 min.

During start-up and run-up pay attention to running noise and temperature development particularly at the bearing points. In the case of unusual running noise, shut down machine and identify fault.
See Section 10: "Faults, causes and remedies."

Apparent leakage at the shaft seal rings

Grease emerging from the lubrication in the shaft seal rings is not an oil leak.

This is an **apparent leakage**, until the remaining lubricant has become regulated.

Wipe off apparent leakage and continue to observe.



Attention against damage to gear unit:

If the new gear unit is started up too quickly, the bearings may overheat, and the tooth flanks may be insufficiently lubricated.

It is necessary to allow the gear unit to run-in in stages!



Warning:

Risk of burns!

Possibility of severe burns on hot surfaces (>55°C).

Wear suitable gloves and protective clothing.

9. Operation of the DynaGear unit

9.1 General notes on operation

The instructions in Section 1 "General safety notes", Section 10 "Faults, causes and remedies", and Section 11 "Inspection and maintenance" must be complied with.

In order to achieve a perfect trouble-free operation of the gear unit, the operating factors defined in the "Technical Data" must be complied with.

9.2 During operation monitor the following:

Operating temperature

When using mineral gear oils (CLP) the operating temperature should not exceed 90°C or only exceed this limit for a short period. If synthetic gear oils (CLP) are used, an operating temperature must be set. In combination with sealing rings made of FKM (fluororubber, Viton), a temperature of 110°C is permissible for a short time. The shaft sealing at the drive shafts are made of FKM by default.

See also number **11.3 “Oil service life”**, page 19.

Changing gear unit noises, vibrations

Oil leakage on the housing and the shaft seal rings

Oil level - to check the oil level, the gearbox must be stopped.

Check oil levels only with the gear unit in a cooled down condition:

- If there is an oil sight glass, the oil level must be in the middle of the oil sight glass
- If without an oil sight glass, the check is carried out at the lower screw plug of a vertical housing surface. The oil level must touch the thread in the housing (see page 12, section 7.1)



Attention:

Insufficient lubrication due to a too low oil level can lead to damage to the gear parts and the bearings.

Carry out a regular oil level check



Warning:

Possibility of severe burns on hot surfaces (>55°C).
Wear suitable gloves and protective clothing.

9.3 Irregularities

In case of changes compared to standard operation, e.g. increased temperatures, noises, vibrations, in case of doubt the gearbox must be shut down to determine the cause. See section 10: "Faults, causes and remedies".

If necessary, consult our service department.

10. Faults, causes, remedy

10.1 General fault indications

The Sections 5 "Safety notes" and 11 "Service and Maintenance" must be observed.

Faults occurring during the warranty period which require repair of the gear unit may only be repaired by employees of the Nidec Graessner service department.

If, after the warranty period, faults occur whose causes cannot be clearly identified, the Nidec Graessner service department must be contacted.

10.2 Possible faults

Faults	Causes	Remedy
Changed operating noise	Damage to gearings Bearing play is increased. Bearing is defective	Check geared components; if necessary, replace any damaged components Adjust bearing play, Contact service department, Replace defective bearing. Contact service department.
Increased temperature at the bearing points	Oil level in the housing is too low or too high Oil is too old Bearing is defective	Check oil level at room temperature, if necessary, replenish or drain oil. Check when the last oil change has been carried out. If necessary, change the oil Check bearing condition; replace, if necessary; contact service department,
Gear unit is oily on the outside	Insufficient sealing of the bearing flanges and gear unit covers	Seal bearing flanges and gear unit covers
Oil leak at the ventilation filter	Oil foams Oil level in the gear unit is too high Incorrect execution of the ventilation	See fault "Oil foams in gear unit" Decrease oil level in gear unit to the pre-specified level Prevent any direct oil injection by attaching suitable extensions or angle pieces
Oil leaks at the shafts	Insufficient sealing of the bearing flanges and gear unit covers Radial shaft seal rings are defective	Check seals, replace if necessary Check radial shaft seal rings, replace if necessary.
Oil foams in gear unit	Water in oil Oil too old (de-foaming agent used up) Unsuitable oils mixed up	Examine oil condition for water ingress by means of a test tube sample. Have the oil sample analysed, change oil. Examine oil, change oil Examine oil, change oil
Water in oil	Water condensates in the gear unit by external climatic conditions, sun, wind, cold: Ambient temperatures change a great deal.	Protect gear unit against temperature influences
Increased operating temperature	Oil level in the gear unit is too high. Oil is too old Oil is highly contaminated	Check oil level. Correct if necessary. Check when the most recent oil change was carried out, change oil Have the oil sample analysed, change oil.

11. Inspection and maintenance

11.1 General notes

All maintenance and service work may only be carried out by qualified personnel.
See "Safety Instructions 3.2"

The gear unit must always be shut down for maintenance and repair work.
The drive unit must be secured against unintentional start-up (key switch, lock) and an information sign must be attached indicating that work is being carried out on the gear unit.

	<p>Warning: High risk of injury due to unintentional start-up of the drive! Before commencing any maintenance work, secure gear unit against any start-up!</p>
	<p>Warning: High risk of injury from dismantling transmission parts (couplings, jointed shafts, belts, etc.) while torsional forces are still acting on the gear shafts! Secure gear shafts against torsional forces and disassemble transmission elements.</p>

11.2 Service intervals

Non-compliance with the maintenance intervals can cause severe damage to the gearbox and the plant.
Therefore, it must be ensured that these maintenance intervals are observed.

Measures	Service intervals	Remarks
Check running noise for any changes	daily	
Check gear unit for leakage	daily	
Check oil level	monthly	
Carry out first oil change	500 operating hours after commissioning	Chapter 11.3
Carry out additional oil changes mineral oil filling	Every 24 months or 10000 operating hours	Chapter 11.3
Carry out additional oil changes synthetic oils	Every 4 years or 20000 operating hours	Chapter 11.3
Check gear unit condition	Every 2 years	Chapter 11.4

11.3 Oil service life

The oil service life at 80°C average oil temperature in the gear unit without serious changes in the oil qualities is specified by the oil manufacturers as a minimum value:

- For mineral oils, biodegradable oils, and physiologically harmless oils: 2 years or 10,000 operating hours
- For synthetic oils (polyalphaolefins and polyglycols): 4 years or 20,000 operating hours

Note on oil service life

The actual oil service life may be longer, and at operating temperatures above 80°C also lower.
Here, the rule applies that a temperature increase of 10°C approximately halves the service life of the oil.

11.4 Oil change

Oil should be drained directly after shutdown whilst the oil is still warm.



Caution:

There is a **risk of burns** on the hot gear unit, and a **risk of scalding** when draining the oil!

Provide for suitable protection measures!

- Unscrew the ventilation filter or remove the upper screw plug on one side of the housing, open the oil drain plug and collect the oil in a suitable container.
- Equip the drain plug with a new copper seal and screw it back into the housing.
- Fill gear unit with oil, see also section 8.
- Reinsert oil filler plug or breather filter.



Material damage

Possible damage to the gear unit due to insufficient lubrication caused by incorrect or mixed oils.

When changing the oil, always refill with the same oil type previously used!

It is not permitted to mix different makes or mineral and synthetic oils. Specifically, hydrocarbon oils must not be mixed with polyglycols. The mixtures may be resinous or clump together and settle in the gear unit.

11.5 Checking the gear unit condition

This check may only be carried out by qualified operating personnel or by the service department of Nidec Graessner. It must be possible to reliably assess what needs to be replaced on the gear unit or to determine that all gear unit parts are in good order.

12. Replacement parts, replacement part stocks, service

12.1 Replacement parts

Wear part packs and replacement parts complete with replacement or repair instructions are available from our service department. The designation and positioning of the individual parts are shown in the associated dimension sheets and replacement part drawings.

12.2 Replacement part stocks

We recommend to keep a stock of the most important replacement parts and wear parts in the vicinity of the place of use of the gear unit, so as to ensure the operational readiness of the gear unit in this way. The parts are shown in the replacement part drawings

12.3 Service department

Should you require **help from our service department** please provide the following details:

- Gear unit type and size
- All data printed on the type plate (see page 9).
- If the type plate is missing, you will find the serial number stamped into the housing.
- Type and scope of the fault
- Suspected cause
- Photographs of any damage (digital)

13. Alphabetic index

Index keyword	Section	Page
Aeration and ventilation filter	8.	16
Basic duties	5.1.	10
Before commissioning	6.4	11
Checking gear unit condition	11.5.	20
Commissioning	8.	16
Conversions and alterations	3.	5
Copyright	1.4.	4
Disposal of the gear unit after use	3.4.	9
Downloads - Notes	1.4, 4.6.	4, 8
During operation monitor the following:	9.2.	17
Environmental protection	5.3	10
Exclusion of liability	1.3.	4
Faults, causes, remedy	10.	18
Fitted components - Notes	7.4	15
Gear unit installation in plant	7.2.	12
General fault indications	10.1.	18
General installation instructions	7.1.	12
General notes on inspection and maintenance	11.1.	19
General notes on operation	9.1.	16
General notes on the operating instructions	1.	4
Inspection and maintenance	11.	19
Installation	7.	12
Installation position (see fitted positions)	7.3.	12
Installation positions:	7.3.	12
Intended use of MS-Graessner gear units	2.	5
Irregularities	9.3.	17
Long-term storage	6.3.	11
Maintenance	11.	19
Oil change	11.4.	20
Oil inspection glass	7.1.	12
Oil quantities	7.1.	12
Oil service life	11.3.	19
Operating temperature	9.2.	17
Operation	9.	16
Performance table: DynaGear	4.4.	8

